



NAUE GmbH

Sondermaschinen - und Filterbau

Am Rotböhl 5
64331 Weiterstadt

Tel. 0 61 50 / 97 38 - 0
Fax. 0 61 50 / 70 18

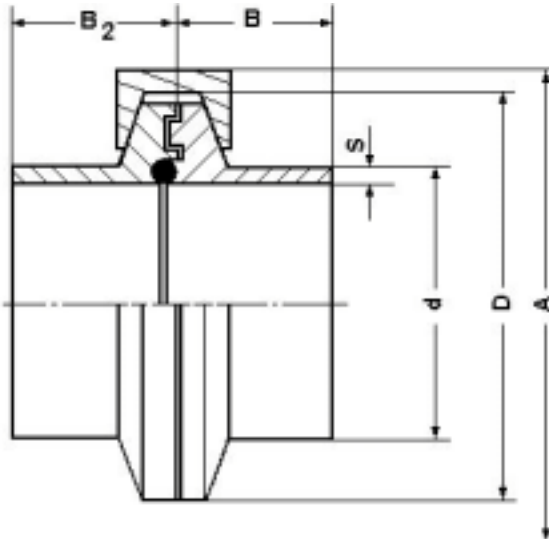

Steril-Klemmring mit zweiseitigem Dichtflächenschutz

Material	Bundstutzen	1.4571 / 316 L
	Nutstutzen	1.4571 / 316 L
	Klammer	A2
Andere Werkstoffe und Abmessungen auf Anfrage		

STANDARD-SCHWEISS-AUSFÜHRUNG

DN	d x s	D Ø	A	B	bar	O-Ring	Klammer Größe	Bestell-Nr.
10	13,0 x 1,5	50,4	60	20	30	10,5 x 2,5	1,5	05-20003
15	19,0 x 1,5	50,4	60	20	30	16,0 x 3,0	1,5	05-20005
20	23,0 x 1,5	50,4	60	20	30	20,0 x 3,0	1,5	05-20006
25	29,0 x 1,5	50,4	60	20	30	26,0 x 3,0	1,5	05-20007
32	35,0 x 1,5	50,4	60	20	30	32,0 x 3,0	1,5	05-20008
40	41,0 x 1,5	64,0	74	20	30	38,0 x 3,0	2,0	05-20009
50	53,0 x 1,5	77,4	88	20	25	50,0 x 3,0	2,5	05-20010

UNIVERSAL-ORBITAL-SCHWEISS-AUSFÜHRUNG

DN	d x s	D Ø	A	B	bar	O-Ring	Klammer Größe	Bestell-Nr.
10	13,0 x 1,5	50,4	60	30	30	10,5 x 2,5	1,5	05-20027
15	19,0 x 1,5	50,4	60	30	30	16,0 x 3,0	1,5	05-20029
20	23,0 x 1,5	50,4	60	30	30	20,0 x 3,0	1,5	05-20030
25	29,0 x 1,5	50,4	60	30	30	26,0 x 3,0	1,5	05-20031
32	35,0 x 1,5	50,4	60	30	30	32,0 x 3,0	1,5	05-20032
40	41,0 x 1,5	64,0	74	30	30	38,0 x 3,0	2,0	05-20033
50	53,0 x 1,5	77,4	88	30	25	50,0 x 3,0	2,5	05-20034

Änderungen vorbehalten









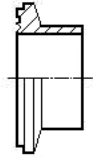
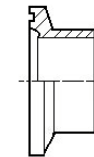
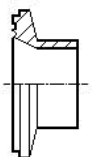
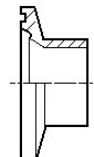

DIN
Baureihe 2

NAUE GmbH

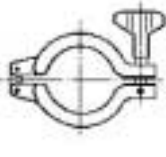
Sondermaschinen - und Filterbau

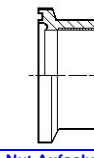
Am Rotböhl 5
64331 Weiterstadt

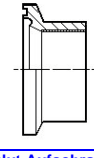
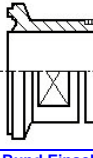
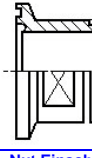
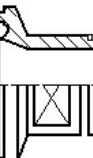
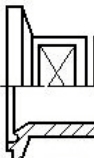
Tel. 0 61 50 / 97 38 - 0
Fax. 0 61 50 / 70 18

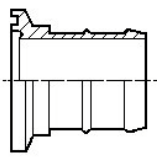
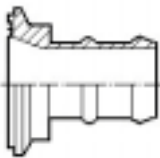
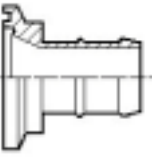
DN	 Bund Anschweiß Klemmring DIN 2	 Nut Anschweiß Klemmring DIN 2	 Bund Anschweiß Klemmring reduziert DIN 2	 Nut Anschweiß Klemmring reduziert DIN 2	 Bund Blindkappe DIN 2	 Nut Blindkappe DIN 2	 Klemmring Verschluss
10	05-20128	05-20103	05-20228	05-20253	05-20303	05-20353	05-00001
15	05-20130	05-20105	05-20230	05-20255	05-20305	05-20355	05-00001
20	05-20131	05-20106	05-20231	05-20256	05-20306	05-20356	05-00001
25	05-20132	05-20107	05-20232	05-20257	05-20307	05-20357	05-00001
32	05-20133	05-20108	05-20233	05-20258	05-20308	05-20358	05-00002
40	05-20134	05-20109	05-20234	05-20259	05-20309	05-20359	05-00002
50	05-20135	05-20110	05-20235	05-20260	05-20310	05-20360	05-00003
DN	 Bund Aufschraub Klemmring DIN 2	 Nut Aufschraub Klemmring DIN 2	 Bund Aufschraub Klemmring reduziert DIN 2	 Nut Aufschraub Klemmring reduziert DIN 2		 Bund Einschraub Klemmring DIN 2	 Nut Einschraub Klemmring DIN 2
10	05-20378	05-20403	05-20428	05-20453		05-20828	05-20853
15	05-20380	05-20405	05-20430	05-20455		05-20830	05-20855
20	05-20381	05-20406	05-20431	05-20456		05-20831	05-20856
25	05-20382	05-20407	05-20432	05-20457		05-20832	05-20857
32	05-20383	05-20408	05-20433	05-20458		05-20833	05-20858
40	05-20384	05-20409	05-20434	05-20459		05-20834	05-20859
50	05-20385	05-20410	05-20435	05-20460		05-20835	05-20860
DN	 Bund Einschraub Klemmring DIN 2	 Nut Einschraub Klemmring DIN 2	 Bund Schlauch Klemmring DIN 2	 Nut Schlauch Klemmring DIN 2	 Bund Schlauch Klemmring reduziert DIN 2	 Nut Schlauch Klemmring reduziert DIN 2	
10	05-20878	05-20903	05-20728	05-20703	05-20803	05-20778	
15	05-20880	05-20905	05-20730	05-20705	05-20805	05-20780	
20	05-20881	05-20906	05-20731	05-20706	05-20806	05-20781	
25	05-20882	05-20907	05-20732	05-20707	05-20807	05-20782	
32	05-20883	05-20908	05-20733	05-20708	05-20808	05-20783	
40	05-20884	05-20909	05-20734	05-20709	05-20809	05-20784	
50	05-20885	05-20910	05-20735	05-20710	05-20810	05-20785	

Änderungen vorbehalten